

Supplementary Figure 1

A

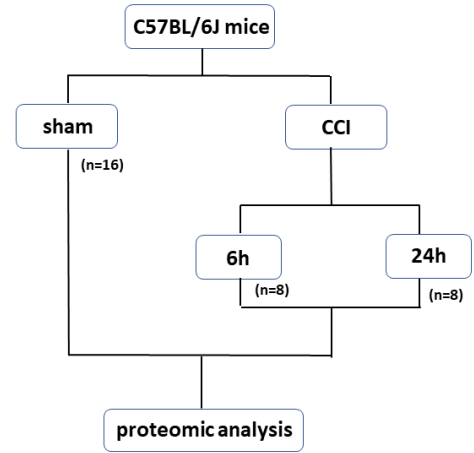

B

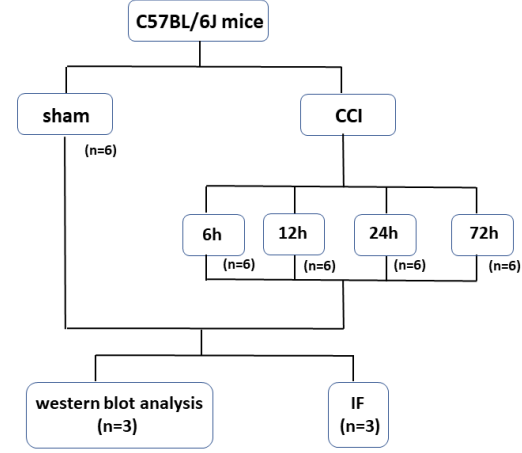

C

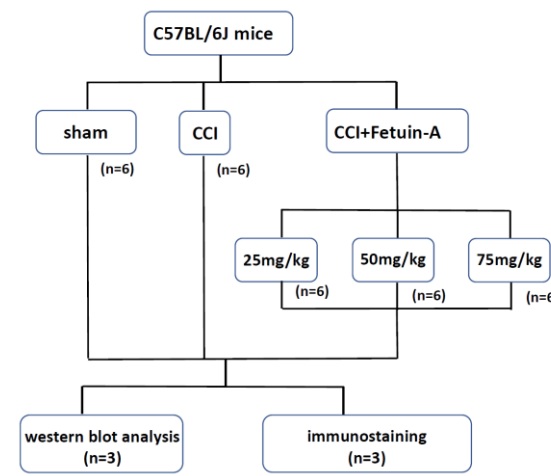

D

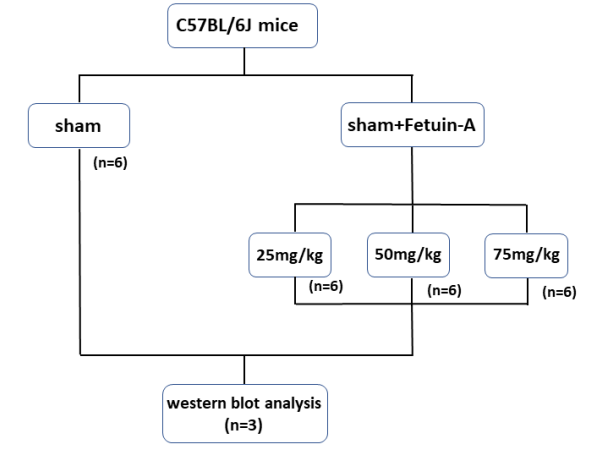

E

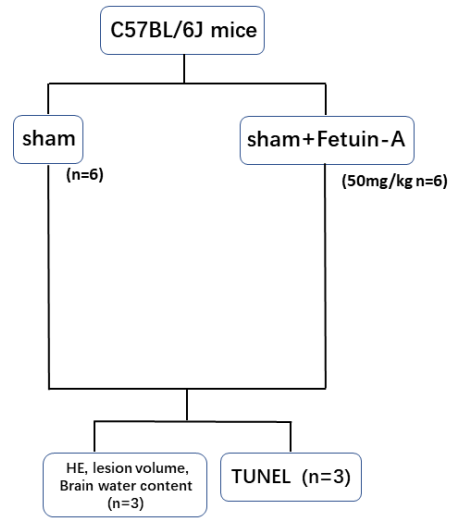

F

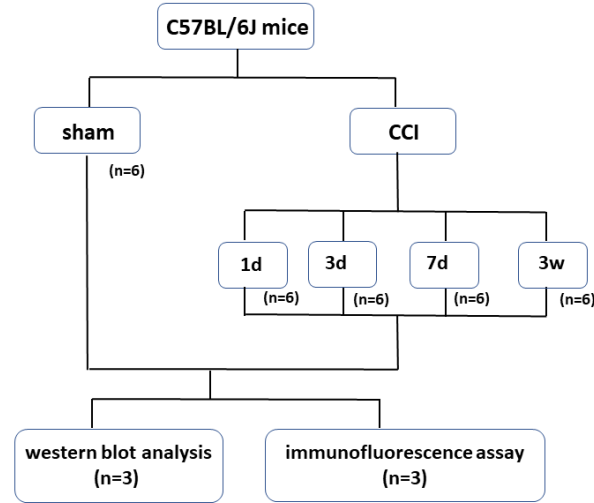

G

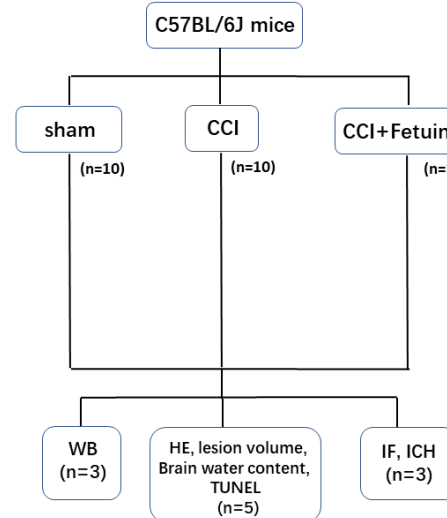

H

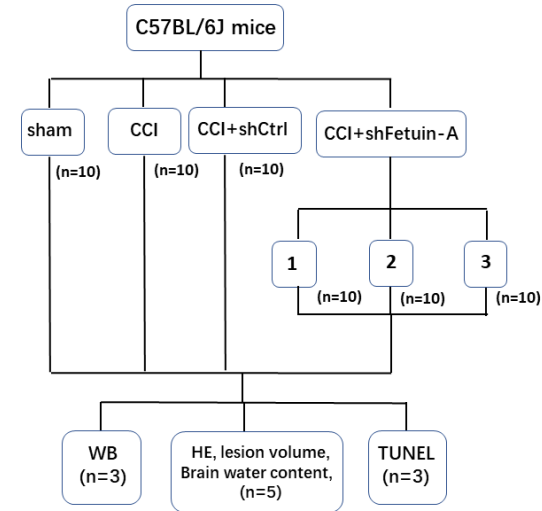

I

